

# CATALOGUE DE LOCATION 2024

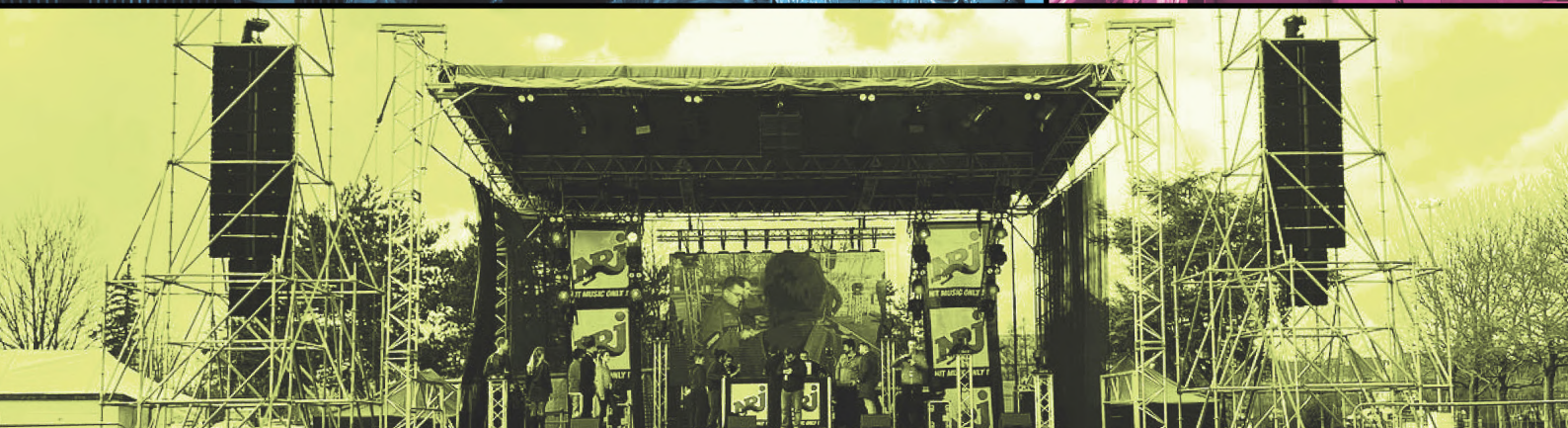



Qui sommes-nous ?

03

Nous trouver

05

Sonorisation

07

Eclairage

27

Effets spéciaux

40

46

Structures et scènes

61

Vidéo

68

Electricité

74

Décorations

81

Bornes photos

# LE RÉFÉRENT TECHNIQUE DE VOTRE ÉVÉNEMENT

Depuis plus de 20 ans, WTECH Group est le partenaire technique événementiel pour la réalisation de vos projets.

Particulier ou professionnel, faites appel à nos services pour la location, la vente et l'installation de matériel de sonorisation, l'organisation de spectacles pyrotechniques, l'installation de scène de spectacle, l'éclairage et la mise en lumière de lieux, la projection vidéo et la captation d'événement, la réalisation et le montage de films.



Un interlocuteur  
unique pour  
votre projet



Transport &  
installation du  
matériel



100% de nos  
clients satisfaits



Intervention sur  
toute la France

**LABEL N°866**



WTECH group est titulaire du label n° 866 des prestataires de service du spectacle vivant.

**3**

# NOTRE SITE WEB

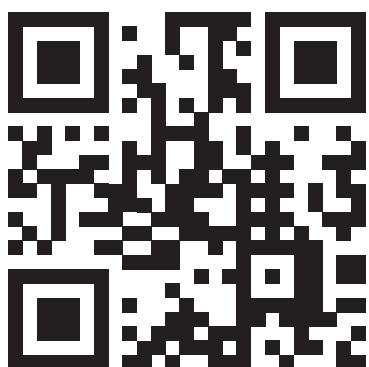

Retrouvez notre site web  
en scannant ce QR code !

# NOS RÉSEAUX



[contact@wtech.fr](mailto:contact@wtech.fr)



[www.wtech.fr](http://www.wtech.fr)



WTECH group

4



# NOUS TROUVER

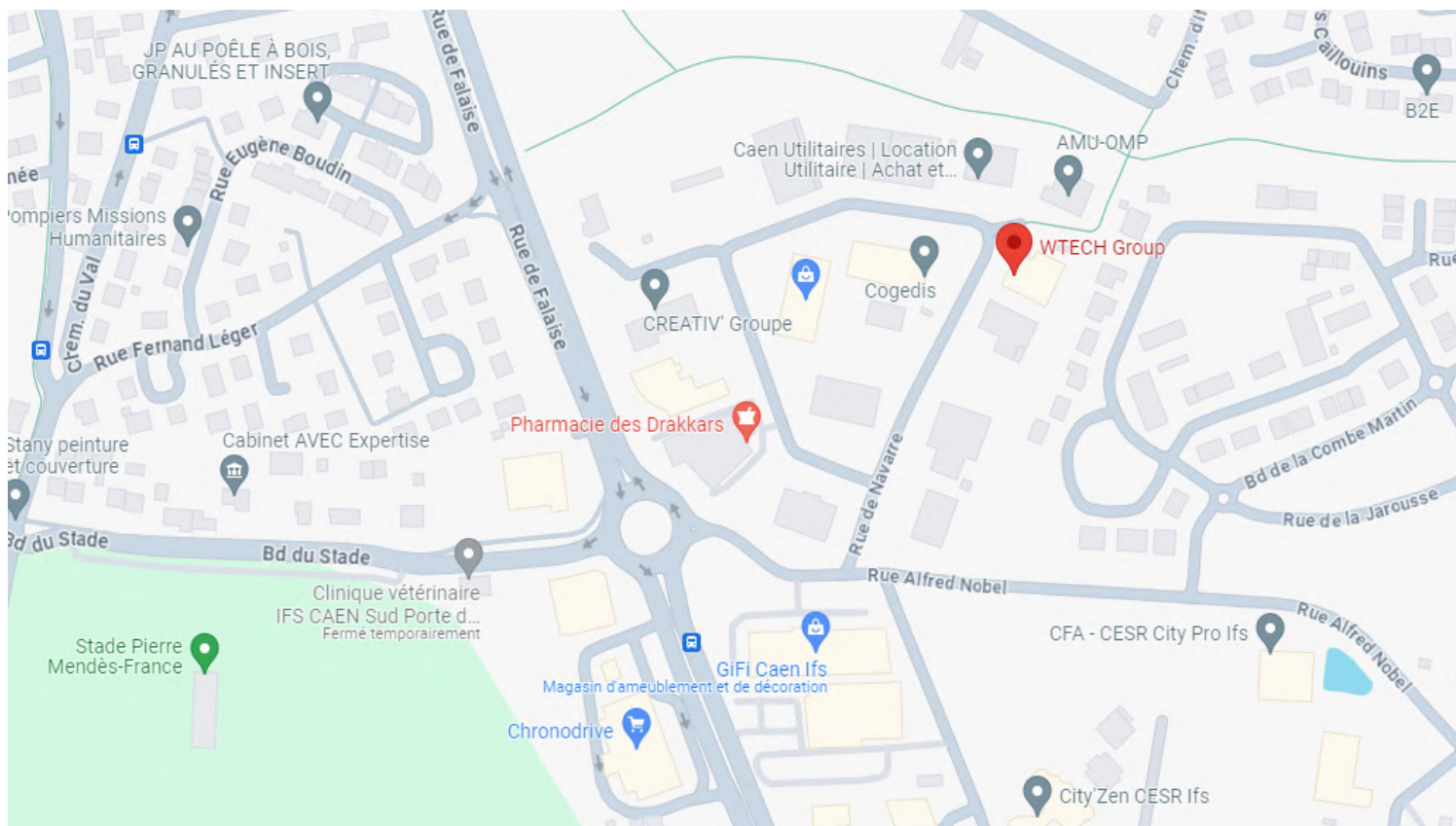

**25 RUE DE NAVARRE**  
**14123 CORMELLES LE ROYAL**



**5**

25 rue de Navarre  
14123 Cormelles le Royal



02 31 73 88 22

# COEFFICIENT DE LOCATION

1	1.00
2	1.50
3	2.00
4	2.30
5	2.50
6	2.75
7	3.00
8	3.30
9	3.70
10	4.00
11	4.20
12	4.40
13	4.60
14	4.80
15	5.00

Notre grille, ci-dessus, vous permet de calculer le coût de location du matériel selon la durée totale d'utilisation que vous aurez prévue :

**TARIF HT / JOUR x COEFFICIENT**

Les coefficients sont dégressifs pour vous permettre d'exploiter le matériel dans les meilleures conditions tarifaires. Ainsi sur des périodes prolongées, vos coûts logistiques seront d'autant mieux amortis.

**LES TARIFS SONT AFFICHÉS EN H.T**

6



A person is seen from the side, operating a large, professional audio mixing console in a recording studio. The console is filled with numerous knobs, sliders, and buttons. The person's hands are positioned on the console, suggesting they are adjusting settings. The background is dark, with some blurred lights, creating a focused and professional atmosphere. A semi-transparent green banner is overlaid across the middle of the image, containing the text "SONORISATION" in white, bold, uppercase letters.

# SONORISATION

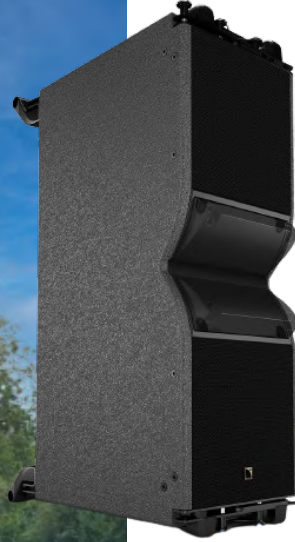
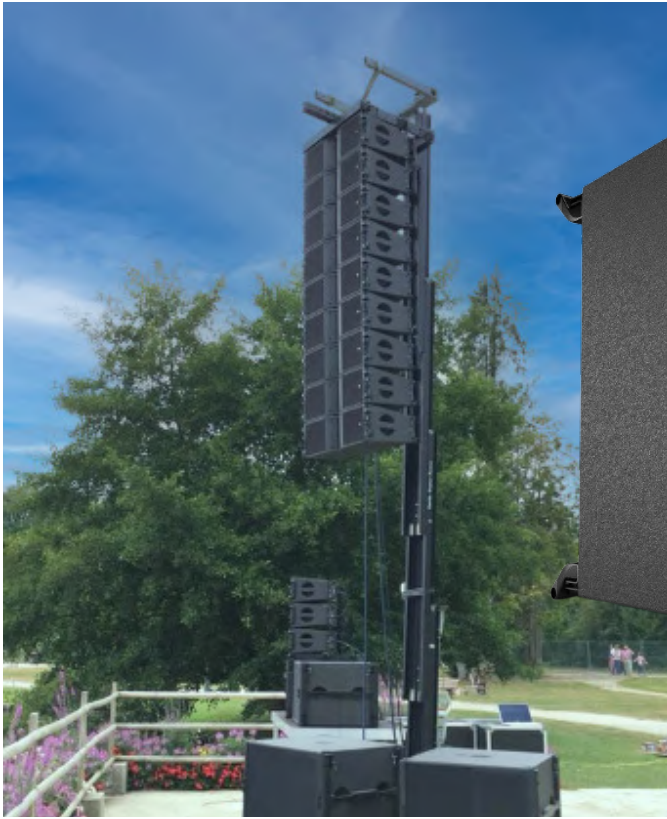

**KARA II** **UPGRADED**

Enceinte active type line array  
2 voies 8"

55€/jour



**BUMP + MBAR**  
Bumper accroche pour  
Kara et SB18

50€/jour



**SB18**  
Subwoofer de 18"  
Accroche compatible avec Kara

40€/jour

**LA8**  
Amplificateur LA8  
4 x 2000W sous 8 ohms

100€/jour



**LA4X**  
Amplificateur LA4X  
4 x 1000W à 8 ohms

85€/jour







**X8**  
Enceinte passive  
2 voies 8"

25€/jour



**X12**  
Enceinte passive  
2 voies 12"

30€/jour



**MTD 112**  
Enceinte passive  
2 voies 12"

25€/jour



**115XT**  
Enceinte active  
2 voies 15"

35€/jour

**ARC**  
Enceinte à courbure  
constante active  
2 voies 15"

55€/jour

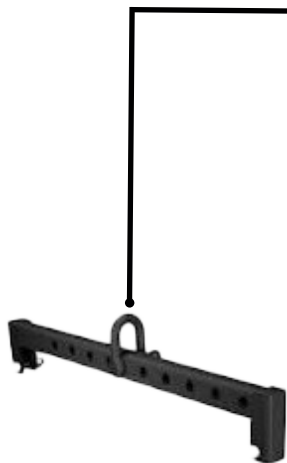

**BUMP 3**  
Bumper pour ARCS  
Position verticale

10€/jour



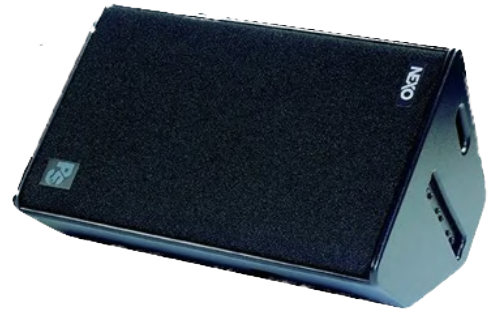

**PS15**  
Enceinte passive de 15"

30€/jour



**SATOC 16**  
Enceinte passive  
8"

15€/jour



**S6**  
Enceinte passive  
6,5"

10€/jour



**CM15**  
Enceinte passive  
15"

20€/jour



**BOSE 802**  
Enceinte passive  
8x8"

25€/jour



## ENCEINTES ACTIVES

audiophony  
EQUIPEMENT



**MT SUB 12A**  
Subwoofer amplifié de 12"

30€/jour



**NOVA 10**  
Enceinte amplifiée de 10"

25€/jour



**NOVA 12**  
Enceinte amplifiée de 12"

30€/jour

## SUPPORTS D'ENCEINTES



**Pied crémallière**

15€/jour



**Pied droit**

10€/jour



**Pied standard**

5€/jour



**Bar liaison**

5€/jour

**Support d'inclinaison**

5€/jour



11



## Support T double

5€/jour

## Support totem

5€/jour



## AMPLIFICATEURS



### DIGAM 7000 Amplificateur 2 x 3500W

60€/jour



### PLX 2402 Amplificateur 2 x 825W

20€/jour

### PLX 3200 Amplificateur 2 x 1050W

25€/jour

## LIGNE 100V



### MP26G APART Projecteur de son ligne 100V 26W

8€/jour



### PC 3301 Amplificateur 2 x 700W

35€/jour

12



**PG48**  
Micro voix  
cardioïde

4€/jour



**SM57**  
Micro instrument  
dynamique cardioïde

5€/jour



**SM58**  
Micro voix  
dynamique cardioïde

5€/jour



**BETA58a**  
Micro voix  
dynamique supercardioïde

7€/jour



**BETA52**  
Micro instrument  
dynamique supercardioïde

10€/jour



**BETA87a**  
Micro voix  
statique supercardioïde

15€/jour



**BETA98**  
Micro statique  
pour instrument

16€/jour





**E901**

*Micro grosse caisse  
cardioïde*

15€/jour



**E604**

*Micro TOMS  
dynamique cardioïde*

6€/jour



**E840**

*Micro voix  
dynamique cardioïde*

5€/jour



**MD421**

*Micro  
dynamique cardioïde*

12€/jour



**E835S**

*Micro voix  
dynamique cardioïde*

4€/jour



**E614**

*Micro statique  
supercardioïde*

9€/jour



**E906**

*Micro dynamique  
supercardioïde*

8€/jour



**E935**

*Micro voix  
dynamique cardioïde*

8€/jour



**E904**

*Micro TOMS  
dynamique cardioïde*

8€/jour



**E908**

*Micro cardioïde  
pour instrument*

16€/jour

## MICROS

**AKG**  
by HARMAN



**C414**  
Micro omni  
cardioïde

31€/jour



**C451**  
Micro statique  
cardioïde

12€/jour



**D112**  
Micro  
grosse caisse

10€/jour



**C535**  
Micro statique  
cardioïde

15€/jour

## MICROS

**DPA**  
MICROPHONES



**DPA 4061**  
Micro miniature omni

35€/jour

**DPA 4488**  
Micro casque cardioïde

35€/jour



**DPA 4099**  
Micro D-VOTE

35€/jour

**DPA 4066**  
Micro casque omni

35€/jour



## MICROS

**AUDIX**



**KM184**  
Micro statique  
cardioïde

18€/jour

**D6**  
Micro  
grosse caisse

20€/jour



15

## PIEDS POUR MICRO



**Petit pied**

4€/jour



**Pied droit**

5€/jour



**Grand pied**

5€/jour

## BOITE DE DIRECT ACTIVE



**BEHRINGER DI100**  
Boîtier de direct

5€/jour

**BSS AR133**  
Boîtier de direct

7€/jour



## LIAISON EAR MONITOR



**EW300 IEM**

35€/jour



**PSM900**

90€/jour



**PSM1000**

120€/jour

16



## LIAISONS HF

SHURE



**EW100 G2**  
Récepteur simple  
micro main type e835

35€/jour



**EW300 G2**  
Récepteur simple  
micro main type e835

40€/jour



**GLDX**  
Récepteur simple  
micro main type sm58 (batterie)

25€/jour



**UR4S+**  
Récepteur simple  
micro main UR2 ou récepteur UR1

80€/jour



**EW100 G4 1G8**  
Récepteur simple numérique  
micro main type e835S

40€/jour

## EMETTEURS

SHURE



**UR1**  
Emetteur pocket

25€/jour



**UR2**  
Emetteur main  
avec capsule interchangeable

25€/jour



**SK100**  
Emetteur pocket

10€/jour

17

# AXIENT® DIGITAL

## High Density Mode



**AD1**  
Boitier ceinture  
Axient Digital

40€/jour



**AD2**  
Micro main  
Axient Digital

40€/jour



**AD4D**  
Récepteur double  
Axient Digital

100€/jour

**WAVENET TENG42**  
Émetteur / récepteur / antenne inclus

350€/jour



18



**A2008**

*Antenne passive directive*

25€/jour



**AD 1800 1G8**

*Antenne active/directive numérique*

20€/jour



**A1031 U**

*Antenne passive omni*

15€/jour



**UA874**

*Antenne active/directive*

28€/jour







**X32**  
Console  
32 entrées / 16 sorties

150€/jour



**TF1**  
Console  
16 entrées / 16 sorties

80€/jour



**SQ5**  
Console  
16 entrées / 16 sorties

150€/jour



**SQ7**  
Console  
32 entrées / 16 sorties

180€/jour





### M7CL

Console 32 entrées / 16 sorties

300€/jour



### CL5

Console 72 entrées / 32 sorties

350€/jour

## MIXAGE ANALOGIQUE

JBSYSTEMS



### MIX 5,2 USB

Console  
4 entrées / 2 sorties

17€/jour



### MG 16fx

Console  
16 entrées / 4 sorties

30€/jour

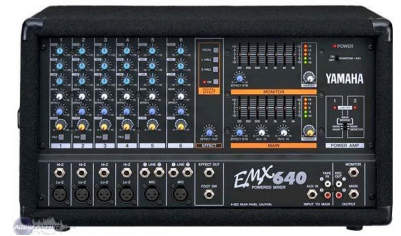

### EMX640

Console 6 entrées / 4 sorties  
Amplificateur 2 x 300W

50€/jour

## PROCESSEURS



### 802C BOSE

Contrôleur analogique  
pour Bose802

20€/jour



### DP6i XTA

Contrôleur numérique 2in / 6 out  
avec logiciel AudioCore

30€/jour



### PS15 TD V1 NEXO

Contrôleur analogique  
pour ps15

20€/jour



NEW



**CDJ3000**

150€/jour



**CDJ2000 NX2**

120€/jour



NEW



**DJMA9**

120€/jour



**SL1210 MK3**

50€/jour

**DJM900 NX2**

120€/jour







**DX168**  
16 entrées / 8 sorties

70€/jour



**S16**  
16 entrées / 8 sorties

40€/jour

**RIO D2 3224**  
32 entrées / 24 sorties

150€/jour



GAMME WTECH GROUP



**MULTI FOH**  
4 x RJ45 / 2 x PowerCon

55€/jour

**RACK FOH**  
2 switch SG310  
PC LA-network + Dante contrôleur  
+ Smart / carte son / onduleur

140€/jour



**RACK STAGE**  
2 switch SG310 / Alim 63A vers 2 x 32A  
Splitter AES / onduleur

80€/jour



**CENTRALE INTERCOM**

**30€/jour**



**BOITIER + CASQUE**

**12€/jour**

**MODULE**

**RJ45**

1m	1€/jour
2m	1€/jour
3m	1€/jour
5m	2€/jour
10m	2€/jour
15m	2€/jour
20m	3€/jour
25m	3€/jour
50m	4€/jour
100m	5€/jour

0.50m	1€/jour
1m	2€/jour
2m	3€/jour
3m	3€/jour
5m	5€/jour
10m	10€/jour
15m	12€/jour
30m	20€/jour
50m	30€/jour
75m	40€/jour

Livré sur enrouleur

Livré sur enrouleur



**KIT 2 FOUETS RJ45/XLR**  
4 x XLR 3p

**10€/jour**



**TRAVERSÉE 32A TETRA**  
1 alim tetra 32A / 2 câbles RJ45

5m	6€/jour
15m	10€/jour
25m	15€/jour



**TRAVERSÉE 32A MONO**  
1 alim mono 32A / 2 câbles RJ45

5m	6€/jour
15m	8€/jour

**MULTIPAIRES**



**MULTI 8**  
8 paires XLR

10m	8€/jour
15m	10€/jour
45m	20€/jour



**MULTI 12**  
12 paires XLR

10m	10€/jour
15m	15€/jour
20m	20€/jour



**MULTI 16/4**  
16/4 paires XLR - 40m  
Option : fouet retour

30€/jour



**MULTI 32/8**  
32 paires XLR + driver 8 paires XLR - 50m  
Option : fouet retour

50€/jour

25



## CABLAGE

### XLR BOSE

10m	1€/jour
25m	3€/jour

### HP 2P

3m	1€/jour
5m	1€/jour
10m	1€/jour
15m	2€/jour
20m	2€/jour
25m	3€/jour

### HP 4P

3m	2€/jour
5m	2€/jour
10m	2€/jour
15m	3€/jour
25m	4€/jour

### HP 8P

10m	3€/jour
15m	4€/jour
2 x 4P	3€/jour
4 x 2P	3€/jour

### CA COM

NEW

DO 10	10€/jour
DO 25	15€/jour
DO FIL	5€/jour
DO SUB	5€/jour

### 4P => 2 x 2P

10m	2€/jour
15m	3€/jour

### 2 x 2P

10m	3€/jour
-----	---------

**Manchon/adaptateur/boitier  
sur demande**

26

A vibrant nightclub scene with a crowd of people dancing under blue laser lights and disco balls. The atmosphere is energetic and festive, with bright blue light beams crisscrossing the dark space. The crowd is silhouetted against the bright lights, and many people have their arms raised in the air. The overall color palette is dominated by deep blues and bright whites from the laser lights.

**ÉCLAIRAGE**



**310H**

Projecteur type PC 1000W

7€/jour



**329HPC**

Projecteur type PC 2000W

15€/jour



**614S**

Projecteur type découpe 1000W

21€/jour



**714S**

Projecteur type découpe 2000W

25€/jour



**PAR 64**

Projecteur type PAR 1000W

6€/jour



**PAR 56 OCTO**

Projecteur type PAR octogonal 300W

5€/jour





## **BARRE ACL**

**2 barres de 4 PAR64  
Avec lampe 250W / 28V ACL**

**45€/jour**



## **KORRIGAN**

**Projecteur type poursuite 1200W HMI**

**135€/jour**



## **FL 1300**

**Projecteur type BLINDER  
2 x 650W**

**12€/jour**



## **BLINDER LED**

**Projecteur type BLINDER  
2 x 100W LED**

**10€/jour**



## **FL 2400**

**Projecteur type BLINDER  
4 x 650W**

**25€/jour**



## **CLAP 1000**

**Projecteur type BLINDER  
4 x 250W**

**15€/jour**

**29**



## SUNSTRIP

Projecteur type rampe T10 10 x 75W

30€/jour



**BT THEATRE 150EZ**  
Projecteur type PC 150W LED

30€/jour

## GAMME VINTAGE



## VINTAGE BLAZE 33

Projecteur type vintage 300W lampe RGBW (led)

45€/jour

30



NEW



**W600 SMD**

Projecteur flood / strobe 504 led smd 21 000 lumens  
Ouverture 110°, IP65, wifi dmx, matricable sur 16 segments

80€/jour

NEW



**ELP PAR**

Projecteur PAR zoom LED 7 x 40W RGBW

35€/jour



**IR LED**

Projecteur PAR LED 18 x 3W RGBW

20€/jour

NEW



**PIX BAR 400 G2**

Bar LED IP65, 16 x 8W ouverture 25-42'

45€/jour



**TOURKOLOR**

Projecteur PAR IP65 180W RGBW

30€/jour

NEW



**BT AKULITE IP**

Projecteur LED sur batterie IP65 6 x 10W

30€/jour





## MAC AURA XIP

*Lyre wash 420W LED RGBW IP55  
Effet filament aura*

110€/jour

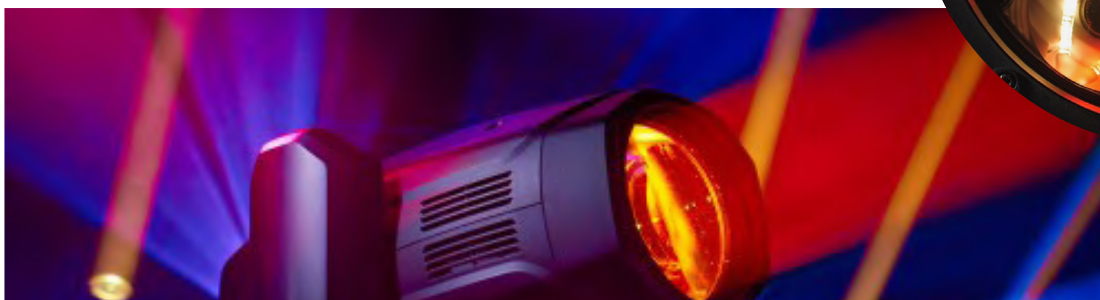
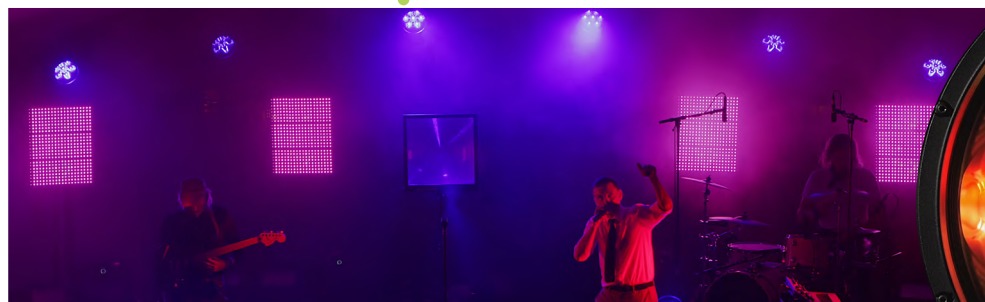

NEW

## AZOR SP2

*Lyre 300W LED avec module couteau, zoom 3-50'  
CMY, 1 roue de couleur, 1 roue de gobo, cto, 1 prism*

100€/jour

## ERA300

*Lyre spot 260W LED, CMY 1 roue de couleur  
2 roues de gobos, prism 5 facettes / iris*

80€/jour



32



**SERVOCOLOR 4K**

*Lyre wash  
285W LED RGBW*

**50€/jour**



**BEAM 7R**

*Lyre beam 280W 1 roue de couleur  
2 roue de gobo / prism 3 et 12 facettes*

**60€/jour**







**INFINIUM 3300**  
RGB

100€/jour

CONSOLES



NEW

**GRAND MA3 LIGHT**  
Console asservis  
15 faders motorisés, 32 univers

380€/jour

**GRAND MA3 COMMAND WING**  
Console asservis  
10 faders motorisés, 8 univers

120€/jour



34





## GRAND MA2 FADER WING

*Extension 15 faders  
4 univers*

**60€/jour**



## GRAND MA2 COMMAND WING

*Console asservis  
5 faders, 2 univers*

**70€/jour**



2 écrans tactiles

6 univers DMX

1 ordinateur

## KIT GRAND MA2 WING + FADER WING

*Consoles asservis 5 faders, 2 univers + extension 15 faders, 4 univers*

**200€/jour**



**35**

# CONSOLES TRADITIONNELLES



**DMX 6**  
Console DMX  
6 canaux

15€/jour



**DMX 12/24**  
Console DMX  
12 / 24 canaux/chasers

25€/jour



**DMX 24/48**  
Console DMX  
24 / 48 canaux/chasers

45€/jour



# GRADATEURS

**ADB STAGELIGHT**  
AN OSRAM BUSINESS



**BLOC 2KW**  
Gradateur 1 x 2 KW

10€/jour



**BLOC 4KW**  
Gradateur 4 x 1 KW

20€/jour



**BLOC 18KW**  
Gradateur 6 x 3 KW

30€/jour



**BLOC 36KW**  
Gradateur 12 x 3 KW

40€/jour

36



**NODES**



**+SWISSON**

**XND-4R8**  
Node RJ45 4 univers



**47€/jour**

**ENREGISTREUR DMX**

**JBSYSTEMS**

**DMX RECORDER**  
8 mémoires

**35€/jour**



**SPLITER DMX**

**eurolite® BriteQ®**

**SPLIT PONT**  
Splitter DMX / powercon

**10€/jour**



**DMS-26**  
Splitter/Merger 2 in / 5 out

**20€/jour**

**LIAISONS DMX**

**+SWISSON**



**XWL-R-WDMX-5**  
Emetteur/Récepteur WDMX

**70€/jour**



**AIR BOX**  
Emetteur/Récepteur DMX

**20€/jour**



**HYBRIDE  
TRUE1 DMX 5P**

3m	5€/jour
5m	7€/jour
10m	8€/jour
15m	9€/jour
20m	10€/jour

**HYBRIDE  
POWERCON DMX 3P**

1m	3€/jour
2m	3€/jour
3m	4€/jour
5m	6€/jour
10m	7€/jour
15m	8€/jour
20m	9€/jour



**KIT 2 FOUETS RJ45/XLR**

4 x 3p

4 x 5p

10€/jour

10€/jour

**DMX 5P**

3m	2€/jour
5m	3€/jour
10m	3€/jour
15m	4€/jour
20m	5€/jour

**DMX 3P**

3m	1€/jour
5m	2€/jour
10m	2€/jour
15m	3€/jour
20m	4€/jour

**SOCAPEX  
6 CIRCUITS 16A**

10m	13€/jour
15m	15€/jour
20m	18€/jour
Fouet 16A	13€/jour
Fouet PC*	15€/jour
Boitier PC*	18€/jour

\*PC : PowerCon

**38**



**ARM-DL32**  
1 x DMS-26 / 1 x BREAK 32  
Bloc 6 x 3 KW  
Patch POWERCON

90€/jour



**ARM-DL63**  
3 x DMS-26 / 1 x PD-63 / 2 x BREAK 32  
Bloc 6 x 3 KW  
Patch POWERCON

190€/jour

LAMPES PHILIPS



**HORIZODE LED**  
50W

15€/jour



**HORIZODE LED**  
150W

20€/jour



**SODIUM**  
400W

15€/jour

The image features a vertical purple-to-white gradient background. In the lower portion, several dark silhouettes of hands are raised, suggesting a crowd or a celebratory event. A dark purple horizontal bar is positioned across the middle, containing the text 'EFFETS SPÉCIAUX' in white, bold, uppercase letters.

# EFFETS SPÉCIAUX





## Z1200

Machine à fumée 1200W

45€/jour



## TOURHAZER II

Machine à brouillard double pompe 1500W

70€/jour



## VULCAN PRO

Geyser de fumée RGBW (6m)

50€/jour



## CO2 JET 230V

Buse CO2 jet

80€/jour





**ATMOSPHERE**  
Générateur de brume  
Avec apport de CO2

130€/jour



NEW

**ME1**  
Générateur de brouillard  
Avec apport de CO2

110€/jour

**MACHINE A ÉTINCELLE**

**SPARKULAR**



**SPARKULAR BIG**  
Machine à étincelles froides (6m)

100€/jour





**X2 12V**  
*Machine à flamme*  
*Effet 6m droit*

**180€/jour**



**GX2 WAVE FLAME**  
*Machine à flamme*  
*Effet 6m motorisé*

**175€/jour**



**Consommables en stock  
sur demande**





**POWERSHOOT II**  
*Lanceur de canon à confettis*

25€/jour

**CANON A CONFETTIS**

Manuel

Electrique

**Tarif  
sur demande**





**Tx2-70k**

*Télécommande tir pyrotechnique hf  
Commande de flamme (portée 1km)*

**135€/jour**



**Rx2-70k**

*Boitier de raccordement  
70 lignes hf*

**130€/jour**



**Rx2-30k**

*Boitier de raccordement  
30 lignes hf*

**80€/jour**



**18r2-hf**

*Télécommande tir pyrotechnique hf  
(portée 300m)*

**40€/jour**



**BORNIER 72m-hf**

*Boitier de raccordement  
30 lignes hf*

**70€/jour**



**MAF 60 II**

*Système de tir  
120 lignes / 5 boitiers*

**85€/jour**

**Pyro de scène sur demande**

**45**



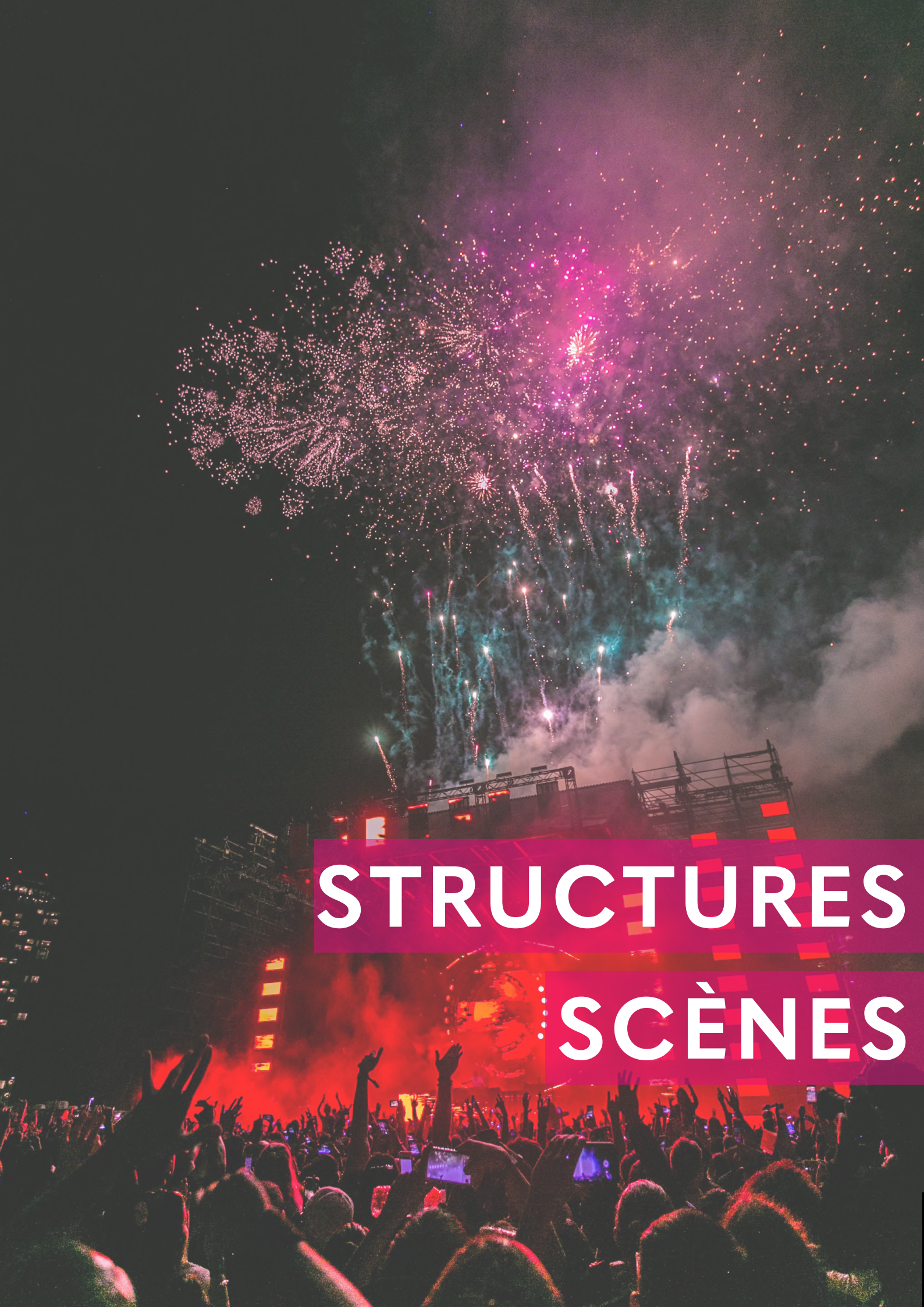

**STRUCTURES**

**SCÈNES**



# STRUCTURES



## MONOTUBE EX50 (ALU)

1m	1€/jour
1.50m	2€/jour
2m	2€/jour
2.50m	3€/jour

## MONOTUBE EX50 (NOIR)

0.50m	1€/jour
1m	2€/jour
1.50m	3€/jour
2m	4€/jour
2.50m	5€/jour
3m	6€/jour



## COLLIER MANCHON 35mm, 50kg

2€/jour



## CERCLE TUBE 2m

10€/jour



## BARRE TCAN 0.50m

10€/jour

47



0.50m	2€/jour
1m	3€/jour
2m	5€/jour

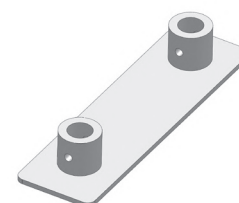
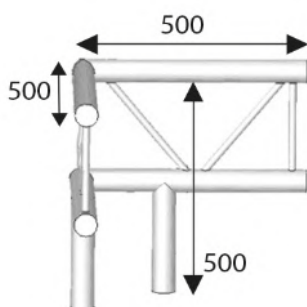
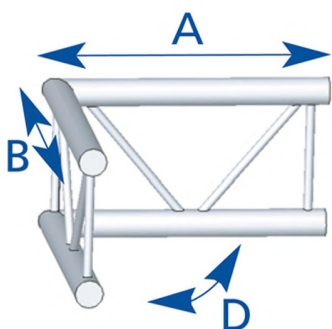

**ANGLE 2D**

5€/jour

**ANGLE 3D**

6€/jour

**EMBASE EMX290**

4€/jour





0.29m	4€/jour
0.50m	5€/jour
1m	6€/jour
2m	11€/jour
3m	16€/jour



**ANGLE 2D**

10€/jour



**ANGLE 3D  
PIED DROIT**

20€/jour

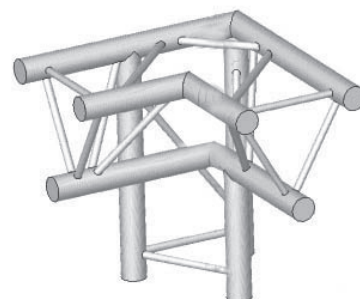

**ANGLE 3D  
PIED GAUCHE**

20€/jour

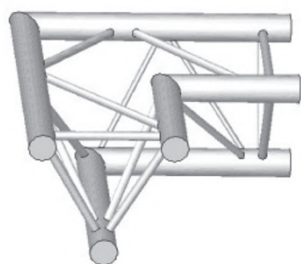

**ANGLE 2D**

10€/jour

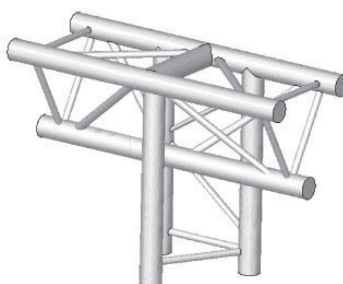

**ANGLE 3D  
PIED T**

25€/jour



**PIED MAGIQUE**

20€/jour



## SC300 (ALU)



1m	6€/jour
1.50m	8€/jour

2m	10€/jour
3m	15€/jour

## 500T (ALU)

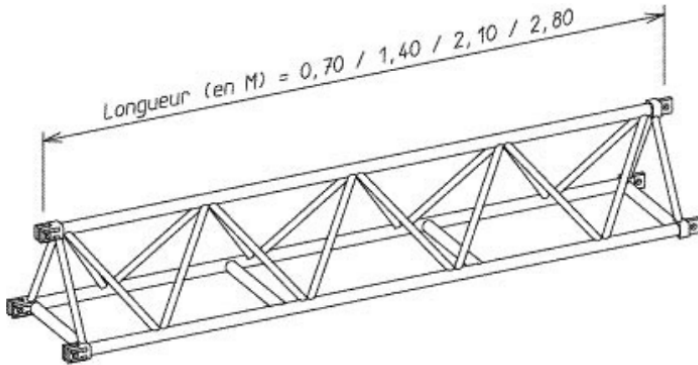

1.40m	10€/jour
2.80m ouvert	18€/jour
2.80m fermé	18€/jour

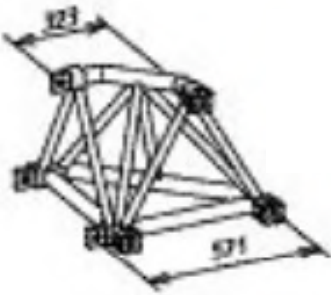

### ANGLE 2D

20€/jour

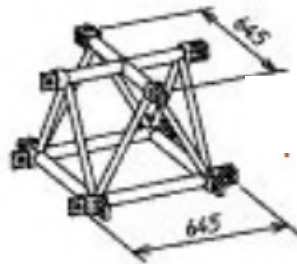

### ANGLE 4D

30€/jour



### ANGLE LINÉAIRE

15€/jour



### ANGLE 4D TIRAGE CENTRAL

50€/jour



50

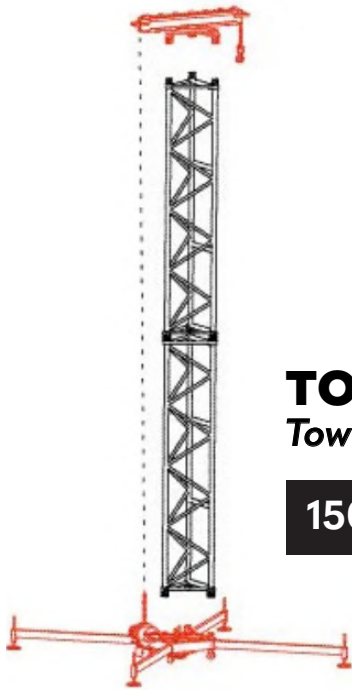

**TOWER 1T**  
Tower avec moteur - H 9m

**150€/jour**

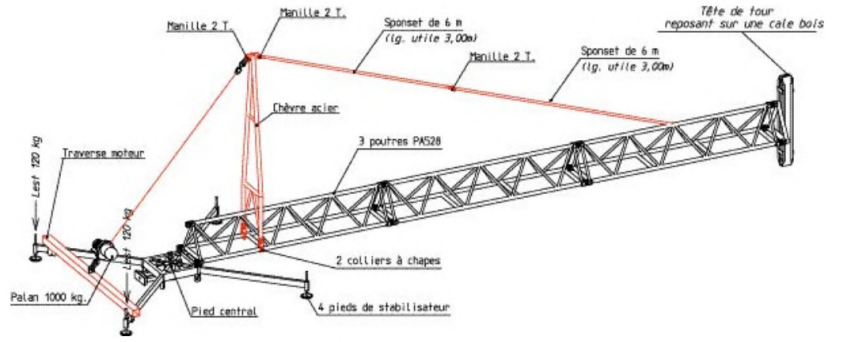

**CHÈVRE DE LEVAGE**  
Montage tower avec palan

**100€/jour**

**PRATICABLES**



**PRATICABLE PIED FIXE**



1 x 1m	10€/jour
2 x 1m	20€/jour
2 x 0.5m	10€/jour

**PIED FIXE (LOT DE 4)**

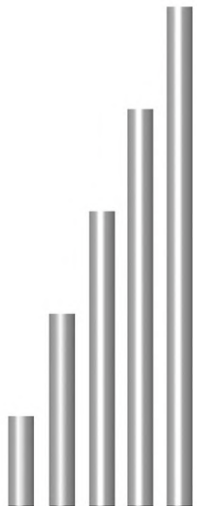

0.20m	2€/jour
0.40m	3€/jour
0.60m	4€/jour
0.80m	5€/jour
1m	6€/jour



**PIED REGLABLE (LOT DE 4)**

0.40 / 0.60m	4€/jour
0.60 / 1m	6€/jour
1 / 1.20m	8€/jour



## ROULETTE Simple

5€/jour



## ROULETTE Double

7€/jour



## ESCALIER 0.40/0.60m

45€/jour



## ESCALIER 0.80/1.40m

80€/jour

## SCÈNE TRADITIONNELLE STACCO

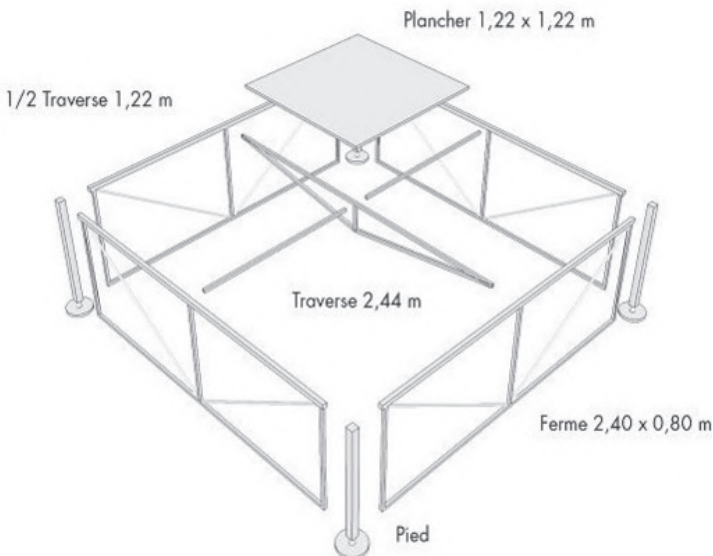

## SCÈNE TRADITIONNELLE H1,20 à 1,90m

Plancher modulaire 2.44 x 2.44m  
2.44 x 1.22m / 1.22 x 1.22m

Sur devis





**ELV 400 PRO**

Pied de levage lumière ou son 4m, 80kg

- Pied à treuil auto-freiné à 3 sections

25€/jour



**TE071**

Pied de levage 5.40m, 220kg

45€/jour



**ST20**

Pied de levage à fourche 6.50m, 360kg

55€/jour



**ST25**

Pied de levage à fourche 8m, 290kg

65€/jour

## LEVAGE



### PALAN A CHAINE

15m, 1000kg

25€/jour



### PALAN A CHAINE

5m, 500kg

10€/jour

## ACCESSOIRES



EMBASES



**EM259**  
Embase légère

5€/jour

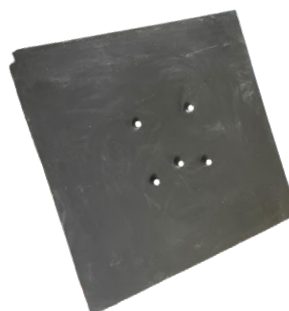

**W100**  
Embase lourde  
1 x 1m, 100kg

35€/jour



**W40**  
Embase semi-lourd  
0.40 x 0.40m, 40kg

25€/jour



**EML259**  
Diam 1m, 80kg

35€/jour

54

**750kg**

1m	1€/jour
1.50m	1€/jour
2m	2€/jour
3m	2€/jour

**1T**

0.50m	1€/jour
1m	1€/jour
5m	3€/jour
10m	5€/jour

**STEEL-FLEX 1T**

0.50m	1€/jour
1m	1€/jour
1.50m	1.50€/jour
2m	2€/jour

**1.5T**

1m	2€/jour
1.50m	2€/jour

1T	1€/jour
2T	2€/jour
3.25T	3€/jour



## CROCHETS



### COLLIER AVEC ANNEAU

50mm, 200kg

2€/jour



### CROCHET ECO

50mm, 200kg

1€/jour



### COLLIER SIMPLE

50mm, 75kg

2€/jour



### COLLIER DOUBLE

50mm, 75kg

1€/jour



### COLLIER SIMPLE

50mm, 500kg

2€/jour



### COLLIER DOUBLE

50mm, 500kg

3€/jour



### CROCHET «SELFLOCK»

50mm, 250kg

2€/jour



### CROCHET «TRIGGER»

50mm, 250kg

2€/jour



## PENDRILLON

1 x 7m	5€/jour
3 x 4m	10€/jour
3 x 7m	20€/jour



## ECHAFAUDAGE

3 niveaux  
Hauteur travail : 2m à 7m

Base	60€/jour
+2m	30€/jour



# SCENES

LES PRIX NE COMPRENNENT PAS LE MONTAGE

STAGECAR III

EUROPODIUM®  
CONCEPTEUR & FABRICANT

**SCENE MOBILE 48m<sup>2</sup>**

Clearance 3 ou 4m

1 390€/jour

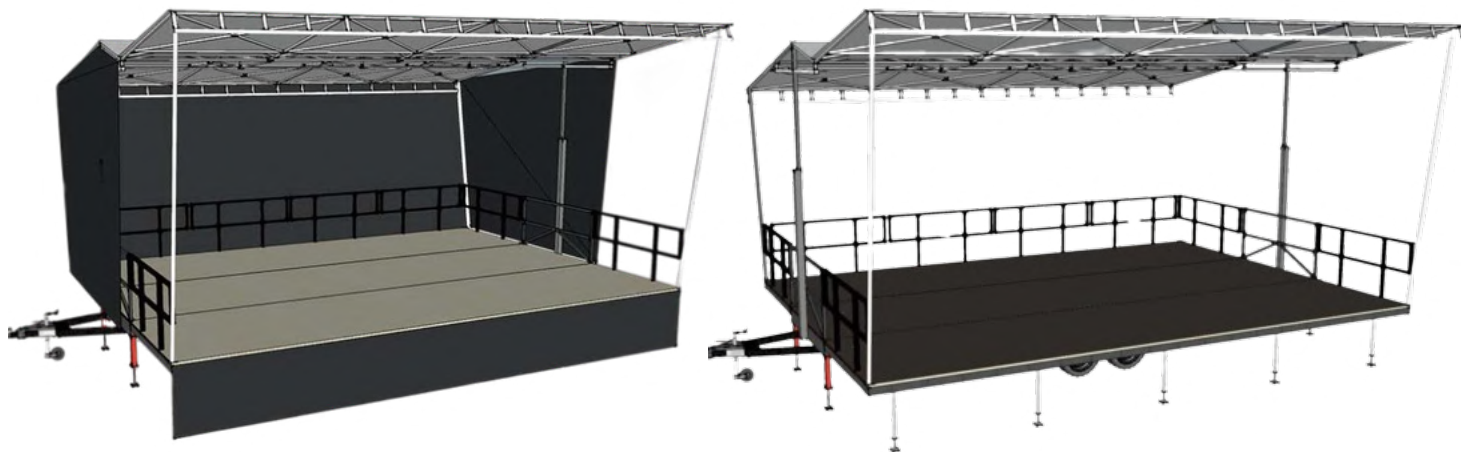

58



OPUS 4200



**SCENE MOBILE 55m<sup>2</sup>**  
Clearance 4.20m hydraulique

1 690€/jour



59



**STAGE 80M2**



## SCENE TRADITIONNELLE 80m<sup>2</sup> SUR MAT

Clearance 7.50m

3 780€/jour



**STAGE 120M2**



## SCENE TRADITIONNELLE 120m<sup>2</sup> SUR MAT

Clearance 7.50m

5 500€/jour



60





# VIDÉO





**ÉCRAN 75"  
VESTEL**

400€/jour

**ÉCRAN 55"  
SAMSUNG**

200€/jour

**ÉCRAN 50"  
SAMSUNG**

150€/jour

**ÉCRAN 46"  
SAMSUNG**

150€/jour

ACCROCHES



**SUPPORT TV**  
*Barre d'accroche murale*

10€/jour

**PIED TV NOIR**  
*H 1.80m*

65€/jour



**IPAD-PDS**  
*Support pour tablette  
H 0.63 / 1.08m*

60€/jour



**SURFACE 3 BF**

*Dalle LED  
Pitch 3,9mm indoor  
Taille 0.50 x 1m  
BLACKFACE*

**120€/jour**



**PROCESSEUR VIDÉO**

*Processeur sx 1000 mk2  
pc portable + switch HDMI*

**150€/jour**

**ECRANS SUR CADRE**

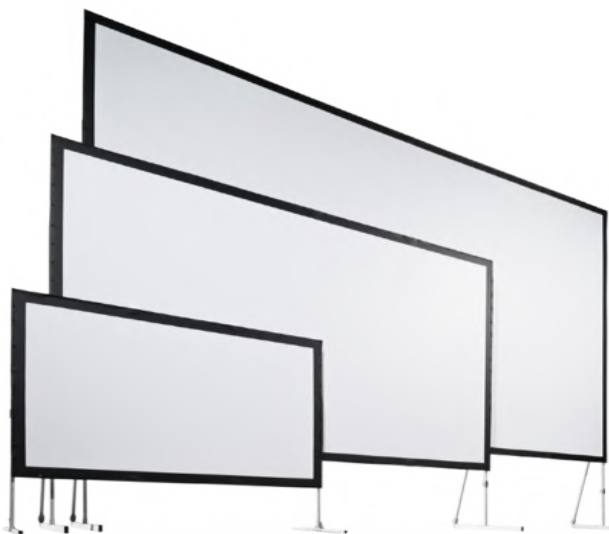

**ECRAN SUR CADRE (16/9)**

3.70 x 2.10m	<b>110€/jour</b>
4.45 x 2.50m	<b>130€/jour</b>
6.30 x 3.60m	<b>450€/jour</b>

## VIDEO PROJECTEURS

Panasonic **EIKI** MITSUBISHI



**XD 600**  
4 500 lumens (XGA)

180€/jour



**PTEZ 570**  
5 500 lumens (FULL HD)

375€/jour



**PTRZ 990**  
10 000 lumens laser (FULL HD)

1100€/jour



**XT5**  
15 000 lumens (XGA)

850€/jour

## Focales sur demande

## CAMERAS

datavideo



**PTC 140**  
Caméra robot zoom 20x  
HDMI / SDI (FULL HD)

200€/jour



**PTC 150**  
Caméra robot zoom 30x  
HDMI / SDI (FULL HD)

250€/jour



**RMC 180**  
Pupitre de commande  
pour caméra robot

95€/jour

64





**ATEM MINI**  
Mélangeur vidéo HDMI

35€/jour



**ATEM TV**  
Mélangeur vidéo SDI / HDMI

80€/jour

Convertisseurs vidéos sur demande

ENREGISTREMENT



**ATOMOS NINJA 2**  
Enregistreur sur disque SSD

40€/jour



**STREAM DECK**  
15 touches Windows / Mac

15€/jour

SERVEURS VIDEO



**BRIGHTSIGN XD234**  
Lecteur multimédia

55€/jour

**ARKAOS**  
15 / 16Go DDR4  
carte vidéo GeForce GTX 1660  
SSD NVMA / Livré avec licence

250€/jour



65



**VILTROX**  
L132T - 3300K / 5600K  
batterie + chargeur inclus

10€/jour

**IANIRO**  
Mandarine - 800W



20€/jour



**NEEWER**  
NL1320 - 52W 3200K / 5600K

25€/jour

MULTIMEDIA

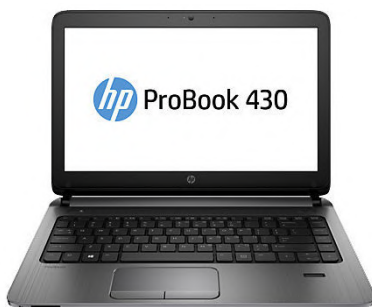

**HP PRO BOOK**  
i3 / SSD 512Go / Mem 16Go

50€/jour



**DELL LATITUDE E7270**  
i5 / SSD 256Go / Mem 16Go  
écran FULL HD

60€/jour



**IPAD 4**  
Couleur blanc

60€/jour

# CABLAGE

## SDI

0.50m	2€/jour
1m	2€/jour
2m	3€/jour
3m	3€/jour
5m	5€/jour
10m	5€/jour
15m	7€/jour
20m	7€/jour
25m	9€/jour
30m	9€/jour
50m	15€/jour
100m	20€/jour



Livré sur enrouleur

## RJ-45

0.50m	1€/jour
1m	2€/jour
2m	3€/jour
5m	5€/jour
10m	10€/jour
15m	12€/jour
30m	20€/jour
50m	30€/jour
75m	40€/jour
100m	50€/jour



Livré sur enrouleur

## HDMI FIBRE

50m	20€/jour
75m	30€/jour



Livré sur enrouleur

## HDMI

1m	1€/jour	10m	3€/jour
2m	2€/jour	15m	4€/jour
3m	2€/jour	20m	4€/jour
5m	3€/jour	25m	5€/jour

67



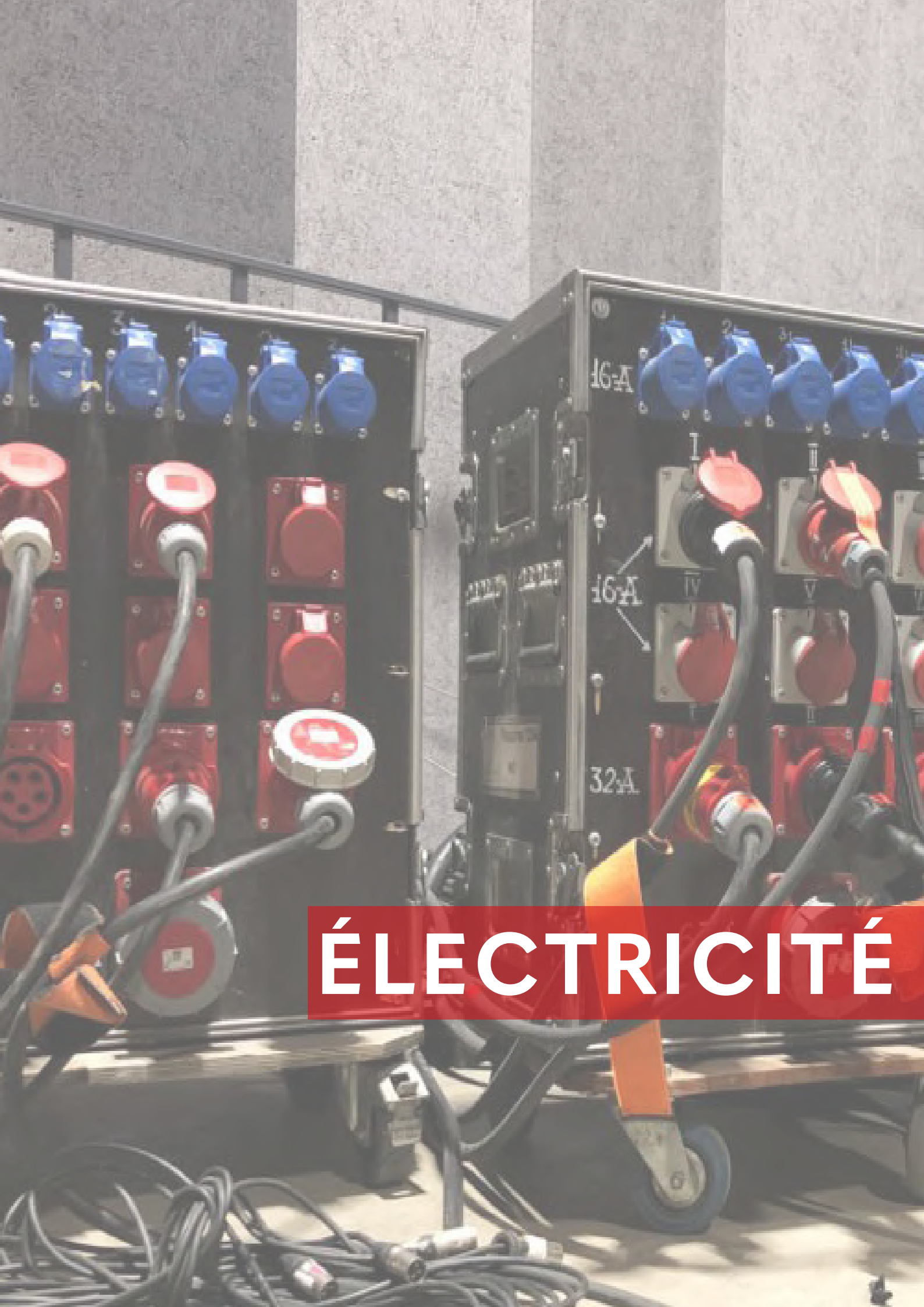

# ÉLECTRICITÉ

## PROLONGATEUR 16A MONO

1m	1€/jour
2m	1€/jour
3m	1€/jour
5m	2€/jour
6m	2€/jour
10m	3€/jour
15m	3€/jour
20m	4€/jour
25m	4€/jour
40m	5€/jour



Livré  
sur enrouleur



## TRIPLETTE 32A TETRA

5€/jour

## PROLONGATEUR 32A MONO

5m	2€/jour
10m	3€/jour
20m	5€/jour

## PROLONGATEUR 32A TETRA

5m	2€/jour
10m	3€/jour
25m	8€/jour

## PROLONGATEUR 63A TETRA

5m	4€/jour
10m	6€/jour
20m	17€/jour

## PROLONGATEUR 125A TETRA

15m	15€/jour
20m	20€/jour

<b>BOITIER 32-M</b>	<b>ENTRÉE</b>		<b>SORTIE</b>	
	<i>Connexion</i>	<i>Protection</i>	<i>Connexion</i>	<i>Protection</i>
 <p><b>20€/jour</b></p>	P17 32A mono	-	2 x 16A	Disjoncteur 16A

<b>ARM 32-M</b>	<b>ENTRÉE</b>		<b>SORTIE</b>	
	<i>Connexion</i>	<i>Protection</i>	<i>Connexion</i>	<i>Protection</i>
 <p><b>25€/jour</b></p>	P17 32A mono	-	12 x 16A Direct out 32A mono	Disjoncteur différentiel 16A

<b>ARM 32T/32M-D</b>	<b>ENTRÉE</b>		<b>SORTIE</b>	
	<i>Connexion</i>	<i>Protection</i>	<i>Connexion</i>	<i>Protection</i>
 <p><b>30€/jour</b></p>	P17 32A tetra	Disjoncteur différentiel tetra 32A  Contacteur d'arrêt d'urgence	3 x P17 32A mono	Disjoncteur mono 32A





<b>BOITIER 32T/16T</b>	<b>ENTRÉE</b>		<b>SORTIE</b>	
	<i>Connexion</i>	<i>Protection</i>	<i>Connexion</i>	<i>Protection</i>
 <p><b>25€/jour</b></p>	P17 32A tetra	-	P17 16A tetra	Disjoncteur tetra 16A

<b>BOITIER 32TD</b>	<b>ENTRÉE</b>		<b>SORTIE</b>	
	<i>Connexion</i>	<i>Protection</i>	<i>Connexion</i>	<i>Protection</i>
 <p><b>25€/jour</b></p>	P17 32A tetra	-	3 x 16A	Disjoncteur différentiel tetra 20A

<b>CH 32-TD</b>	<b>ENTRÉE</b>		<b>SORTIE</b>	
	<i>Connexion</i>	<i>Protection</i>	<i>Connexion</i>	<i>Protection</i>
 <p><b>40€/jour</b></p>	P17 32 tetra	Disjoncteur différentiel tetra 32A	4 x 16A P17 2 x 32A mono	Disjoncteur 16A Disjoncteur 32A

<b>BREAK-32</b>	<b>ENTRÉE</b>		<b>SORTIE</b>	
	<i>Connexion</i>	<i>Protection</i>	<i>Connexion</i>	<i>Protection</i>
 <p><b>40€/jour</b></p>	P17 32A tetra	Disjoncteur différentiel tetra 32A	6 x 16A Direct out P17 32 tetra	Disjoncteur 16A

<b>ARM 32T</b>	<b>ENTRÉE</b>		<b>SORTIE</b>	
	<i>Connexion</i>	<i>Protection</i>	<i>Connexion</i>	<i>Protection</i>
 <p><b>35€/jour</b></p>	P17 32A tetra	-	12 x 16A Direct out P17 32A tetra	Disjoncteur 16A

<b>ARM 32T-D</b>	<b>ENTRÉE</b>		<b>SORTIE</b>	
	<i>Connexion</i>	<i>Protection</i>	<i>Connexion</i>	<i>Protection</i>
 <p><b>40€/jour</b></p>	P17 32A tetra	Disjoncteur différentiel 32A	6x16A 1 x P17 32A tetra	Disjoncteur 16A Disjoncteur différentiel 32A

ARM 63T/32T-D	ENTRÉE		SORTIE	
	Connexion	Protection	Connexion	Protection
 <b>60€/jour</b>	P17 63A tetra	Disjoncteur différentiel tetra 63A	4 x P17 32A tetra	Disjoncteur tetra 32A
		Contacteur d'arrêt d'urgence		

BOITIER 63T/32T	ENTRÉE		SORTIE	
	Connexion	Protection	Connexion	Protection
 <b>40€/jour</b>	P17 63 tetra	-	2 x P17 32 tetra	Disjoncteur tetra 32A

PD-63A	ENTRÉE		SORTIE	
	Connexion	Protection	Connexion	Protection
 <b>45€/jour</b>	P17 63A tetra	Disjoncteur différentiel tetra 63A	2 x P17 32A tetra	Disjoncteur 32A
			3 x 16A	Disjoncteur 16A



<b>ARM 63T-D</b>	<b>ENTRÉE</b>		<b>SORTIE</b>	
	<i>Connexion</i>	<i>Protection</i>	<i>Connexion</i>	<i>Protection</i>
  <b>100€/jour</b>	P17 63A tetra	Disjoncteur différentiel 63A tetra	2 x P17 32A tetra	Disjoncteur 32A tetra
		Contacteur fil pilote	2 x P17 32A mono	Disjoncteur différentiel 32A
		Contacteur d'arrêt d'urgence	4 x P17 16A mono	Disjoncteur différentiel 16A
		Centrale de mesure		

<b>ARM 125T-D</b>	<b>ENTRÉE</b>		<b>SORTIE</b>	
	<i>Connexion</i>	<i>Protection</i>	<i>Connexion</i>	<i>Protection</i>
  <b>90€/jour</b>	P17 125A tetra	Disjoncteur différentiel 125A tetra	2 x P17 63A tetra	Disjoncteur 63A tetra
		Contacteur fil pilote	4 x P17 32A tetra	Contacteur fil pilote
		Arrêt d'urgence	6 x 16A	Disjoncteur 32A tetra
				Disjoncteur 16A

## ACCESSOIRES



### TRAVCAB

Goulotte de plancher (1 et 2m)

7€/jour



### PASCAB

Passage de câble - 2 canaux (1m)

10€/jour

## SÉCURITÉ



### BLOC DE SECOURS

BAES standard

10€/jour



### PR-1106

Preamplificateur 6 entrées  
carte «message d'évacuation» AZ1253

50€/jour



### NAVIS Y211

Anémomètre avec alarme

40€/jour

75

The image features a dark background filled with out-of-focus, circular light spots in shades of yellow, orange, and light blue, creating a bokeh effect. A horizontal purple bar is positioned in the lower-middle section, containing the word "DÉCORATIONS" in white, bold, uppercase letters.

**DÉCORATIONS**



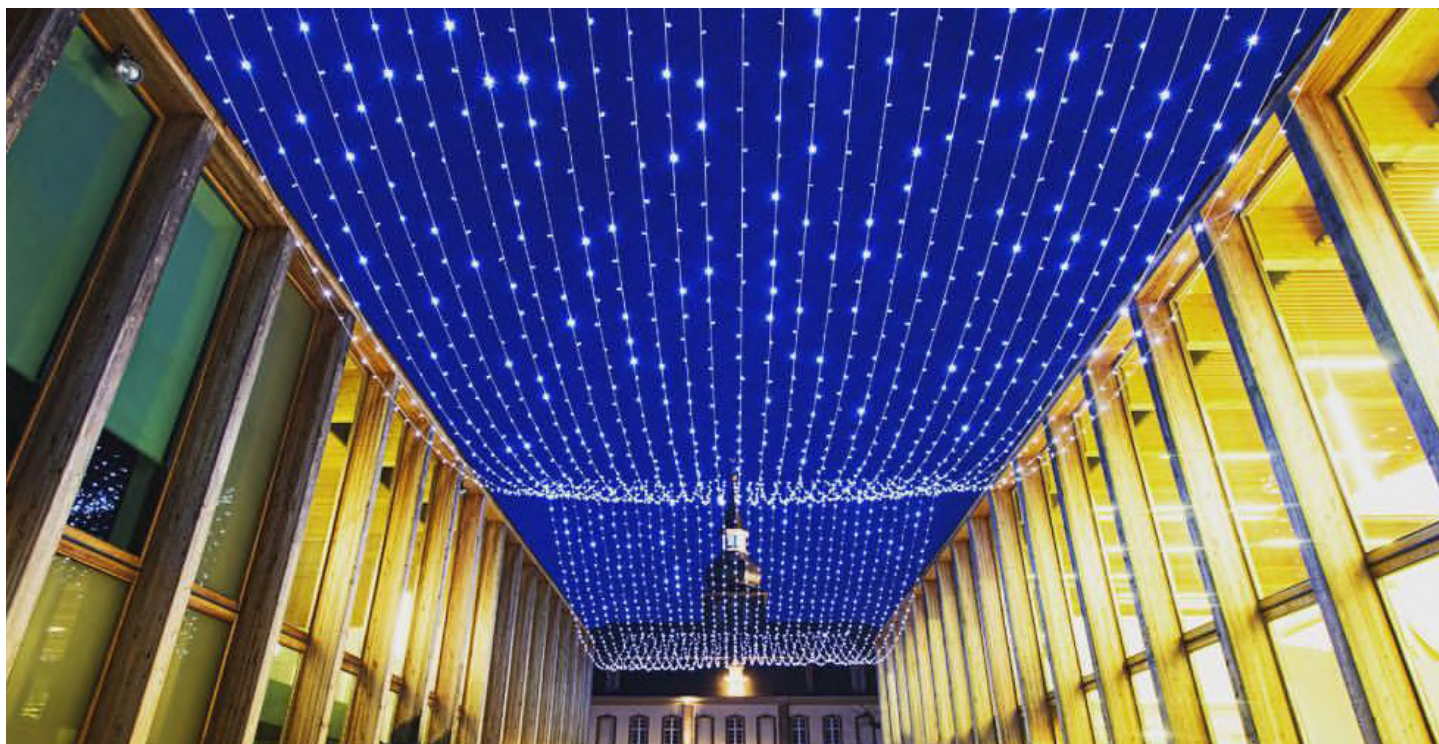





**Guirlande guinguette**  
*Câble noir*

**1€ le mètre/jour**

**Guirlande blanc chaud**  
*Câble noir/blanc*

**0.80€ le mètre/jour**

**Autres guirlandes ou rideaux lumineux  
sur demande**

**78**

## LETTRES LUMINEUSES



50€/jour

## BOULES A FACETTES



30cm

5€/jour

50cm

10€/jour

1m

80€/jour

40cm

7€/jour

80cm

40€/jour

## POTELET



### POTEAU DE GUIDAGE

H 90cm / L 2m - Plastique noir

20€/jour

79



# BAR



30€/jour



**POSSIBILITÉ  
D'AJOUTER DES  
ÉTAGÈRES**

80





# BORNES PHOTOS

Selfizee™



## BORNE CLASSIK



- Ecran king size 20 pouces
- Imprimante intégrée DNP
- Réflexe canon EOS
- Eclairage LED puissant
- Processeur dernière génération

450€/jour



## Intégralement personnalisable



82



## BORNE SPHERIK

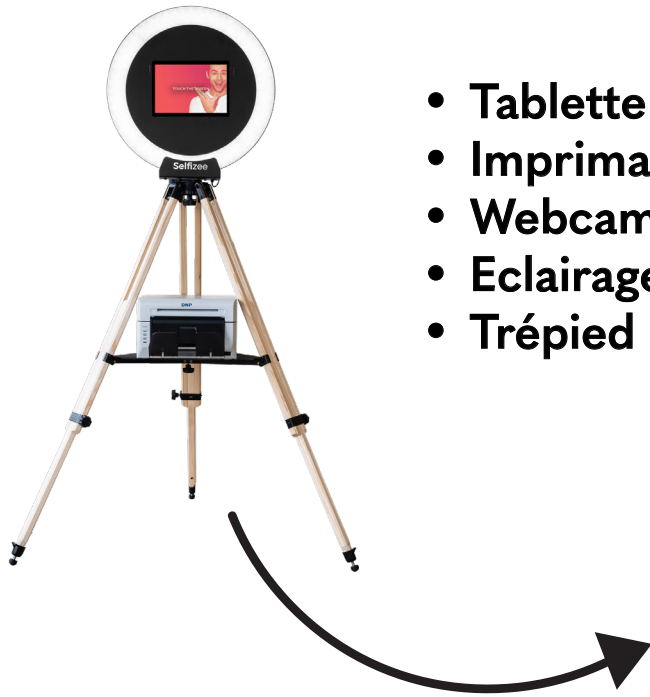

- Tablette windows surface 10 pouces
- Imprimante professionnelle DNP
- Webcam HD 4K
- Eclairage LED puissant
- Trépied en bois renforcé

390€/jour



## Faces avant/arrière personnalisables



83

## BORNE PRESTIGE



- Tablette windows surface 10 pouces
- Imprimante professionnelle DNP
- Webcam HD 4K
- Eclairage LED puissant
- Pied droit métallique

450€/jour



## Faces avant/arrière personnalisables



84

## 1. RÉSERVATIONS

1-1 Toute réservation implique l'adhésion sans réserve à nos conditions générales de location quelques soient les clauses figurant au sein des bons de commande des clients.

1-2 Toutes les réservations doivent faire l'objet d'un écrit, courrier ou fax, de la part du client au moins 24h00 à l'avance et ne sont acceptables que dans la limite des stocks disponibles.

Le matériel faisant l'objet d'une réservation acceptée demeure disponible 24h00 maximum après la date de départ prévue.

1-3 Dans le cadre d'une annulation de réservation, tous les acomptes déjà versés restent acquis à WTECH GROUP à titre de dédommagement forfaitaire.

1-4 Le client devra signaler lors de sa réservation si le matériel doit sortir du territoire national.

## 2. PROPRIÉTÉ

Le matériel est la propriété de WTECH GROUP, à ce titre il est insaisissable par les tiers et le locataire n'a pas le droit de le céder ou de le sous-louer. Il ne doit apporter aucune modification superficielle ou substantielle au matériel.

## 3. DURÉE DE LA LOCATION

3-1 Le bon de livraison obligatoirement délivré à chaque sortie de matériel indique la date et l'heure du retrait ainsi que la date présumée du retour.

3-2 Seul le retour physique du matériel en nos locaux détermine la durée de location, décomptée en journées de 24h00, dimanche et jours fériés compris, sans tenir compte de l'utilisation ou non du matériel.

## 4. RETRAIT DU MATÉRIEL

4-1 Le client réceptionne le matériel loué en nos locaux du lundi au vendredi de 09h30 à 12h30 & de 14h00 à 18h00. Éventuellement le samedi de 09h30 à 12h30.

4-2 Le retrait du matériel s'effectue en échange d'un dépôt de garantie (à la discrétion de WTECH GROUP, soit au moins 10 fois le montant de la location d'une journée, soit 2 fois le loyer de la période) accompagné de la totalité du règlement de la location ou d'un bon de commande pour les sociétés ayant un compte ouvert dans nos registres.

4-3 Une quittance PTT ou EDF libellée à l'adresse des chèques sera demandée aux particuliers.

4-4 Le client qui le désire est convié à assister à l'essai du matériel mis en oeuvre systématiquement avant chaque départ. Après essai concluant, le matériel est considéré en parfait état de fonctionnement même si le client n'a pas assisté au test.

## 5. RESTITUTION DU MATÉRIEL

5-1 Le client est tenu de restituer le matériel loué à la date figurant sur le contrat de location.

5-2 Toute prolongation de location devra être signalée 24h00 avant le retour prévu initialement. Elle ne pourra avoir lieu qu'après l'accord de WTECH GROUP et devra dans tous les cas être confirmée par un nouveau bon de commande. En cas de prolongation, les principes de facturation appliqués à la commande ne seront pas forcément maintenus.

5-3 Toute restitution non justifiée après la date prévue, entraînera la responsabilité du client pour les préjudices subis par la société WTECH GROUP et sa clientèle.

5-4 Tout matériel manquant ou détérioré sera facturé sur la base du tarif " WTECH GROUP " en vigueur valeur neuve. Un délai supplémentaire de 48h00 est admis pour la restitution de petits matériels et accessoires manquants au retour ; passé ce délai, la facturation deviendra définitive. Les lampes restituées hors service seront facturées à 70 % de leur valeur neuve.



## 6. TARIFS

Les prix facturés sont ceux du tarif en vigueur au jour de la livraison, WTECH GROUP se réservant le droit de modifier ses tarifs à tout moment sans préavis. Le taux de T. V. A. appliqué est de 20% sur l'ensemble des services offerts.

## 7. CONDITIONS DE RÉGLEMENT

7-1 Un acompte de 30% sera versé à la commande et le solde le jour de la livraison.

7-2 Un chèque de caution peut vous être demandé et sa valeur sera égale à 10 fois le montant de la location.

7-3 WTECH GROUP, sous réserve de l'accord de son service financier, pourra procéder à des ouvertures de compte pour ses clients.

7-4 Conformément à l'article 3 de la loi n°92-1442 du 31 décembre 1992, les prorogations d'échéances entraîneront automatiquement la perception d'agios au taux de 1,5 fois le taux d'intérêt légal.

7-5 Le non-respect par le locataire de l'une quelconque de ces obligations aura pour conséquence :

- l'exigibilité immédiate de toute somme restante due, sans prendre en compte le mode et le terme de paiement initialement prévu.
- le paiement, à titre de clause pénale, en sus d'une indemnité, pour frais de recouvrement de 15 % sur le montant des sommes exigibles sous réserve de tous autres dus.
- l'autorisation pour WTECH GROUP de surseoir à de nouvelles livraisons.

## 8. RESPONSABILITÉS

8-1 Le locataire en qualité de dépositaire assume l'entière responsabilité du matériel dès sa prise en charge en nos locaux et jusqu'à sa restitution. Il est seul responsable de tous dégâts causés au matériel ou du fait du matériel.

8-2 Le locataire doit se préoccuper d'avoir les autorisations nécessaires pour l'utilisation des émetteurs H.F. audio et vidéo, talkie-walkie, radio, téléphone, etc.

8-3 L'indemnisation du matériel sinistré s'effectue sur la valeur de remplacement à neuf au jour du sinistre, sans application de dépréciation ni remise commerciale suivant le prix de vente public ou sur la base des frais de remise en état au coût du jour.

8-4 Le locataire doit utiliser le matériel conformément à sa destination.

8-5 La responsabilité de WTECH GROUP ne saurait être engagée suite au non-fonctionnement ou mauvais fonctionnement des appareils loués liés à l'adjonction de matériels non compatibles, ou à une mauvaise installation.

## 9. ASSURANCES

9-1 Le locataire doit assurer le matériel pour sa valeur de remplacement à neuf.

9-2 L'assurance doit notamment couvrir les risques de vol, perte ou détérioration quelle qu'en soit la cause ou la nature.

9-3 Le locataire fait son affaire de tous risques de mise en jeu de sa responsabilité civile, à raison de tout dommage causé par le matériel ou à raison de toute utilisation pendant qu'il est sous sa garde.

## 10. CLAUSE RESOLUTOIRE

À défaut par le locataire d'exécuter l'une quelconque des conditions générales de location, la résiliation de la location sera encourue de plein droit, 48 heures après une mise en demeure restée infructueuse et sans autre formalité judiciaire. Si le locataire refusait soit de payer soit de restituer le ou les matériels, les sommes versées en dépôt resteraient acquises au loueur, sans préjudice de tous les dommages et intérêts qui pourraient être réclamés par ailleurs.

## 11. LITIGE

En cas de litige, le Tribunal de commerce de CAEN (14) sera seul compétent.

